

100W LED Parking Lot

LV-PKL-100W-X* + (Photocell) [X represents bracket type]



Lighting

- Lamp Power: 100W
- Lumen output: 11500lm
- Efficiency: 1150lm/w
- Color Temperature: 3000K, 5000K
- CRI: Ra > 70
- IES Classification Standard: Type III Distribution
- IES Classification Optional: Type IV & Type V

Electrical

- Voltage Input: 100-277V ac
- Max. Input current: 0.95Amp@100Vac
- Dimmable: Non/1-10V Dimming
- Driver Power Factor: > 0.95%
- Driver Efficiency: 96%

Others

- Housing Material: Aluminum
- Lens: PC
- IP Rating: Ip66 For Wet Location
- Operating Temp.: -40°C ~ 40°C (-104°F ~ 104°F)
- Certificates: ETL/cETL, DLC
- Warranty: 5 years
- L70 life span: > 50000Hrs
- Accessories options:
 - Photocell
 - Shorting cap
 - Mounting adaptors type A/B/C/F

Lux Chart/Photometrics

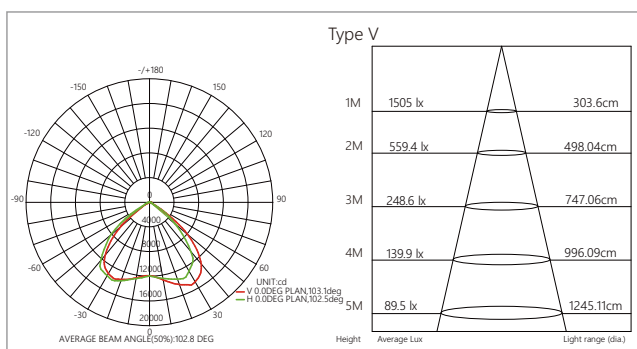
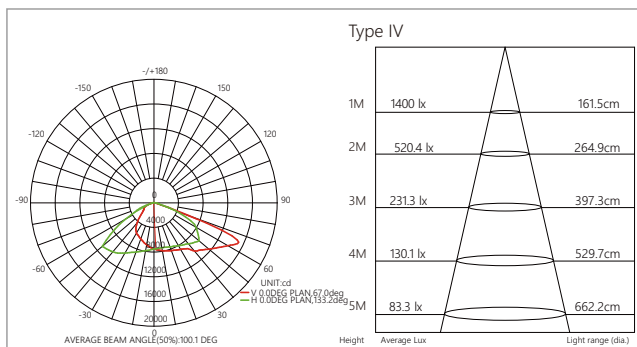
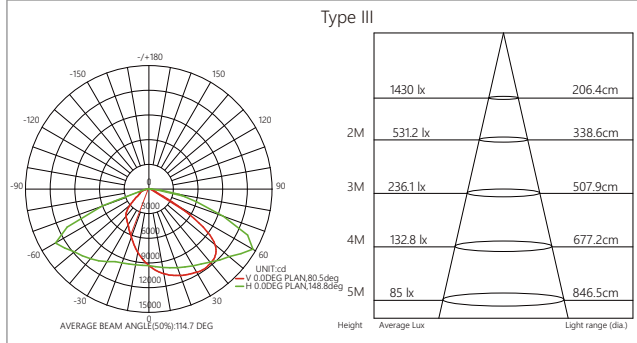

Size

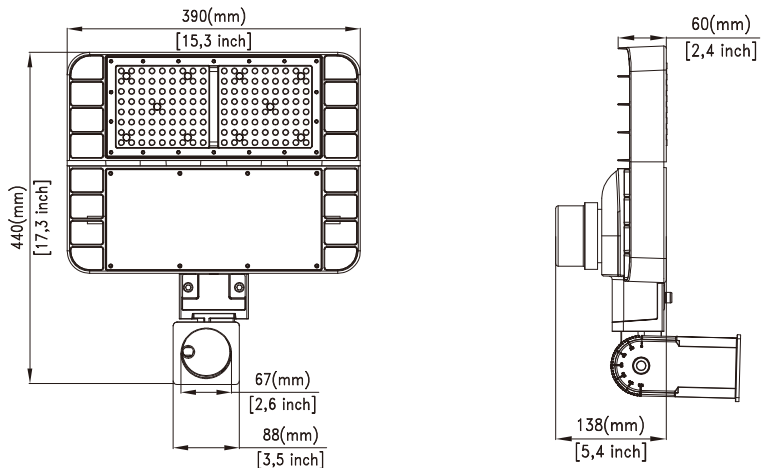

Photocell option



Packaging

Dimension: 20.9" L x 17.3" W x 5.9" H
(530mm x 440mm x 150mm)

1pcs/CTN G.W.: 6.25kg

Container
40'hq 2052 pcs
40'gp 1784 pcs
20'gp 884 pcs

Mounting Adaptor Options X*

*X represents A/B/C/F

